

UNCONTROLLED DOCUMENT

PART NUMBER		REV.
SML-LXR851UPGC-TR		A

REV.	E.C.N. NUMBER AND REVISION COMMENTS	DATE
A	E.C.N. #10967.	9.07.04

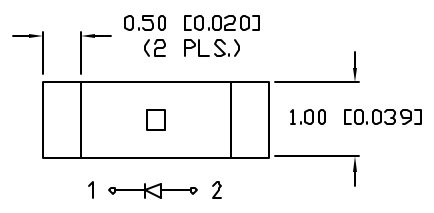

CAUTION: STATIC SENSITIVE DEVICE
FOLLOW PROPER E.S.D. HANDLING PROCEDURES
WHEN WORKING WITH THIS PART.

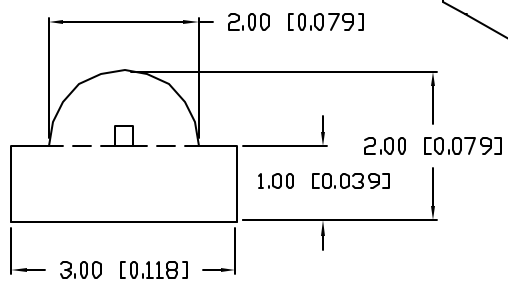
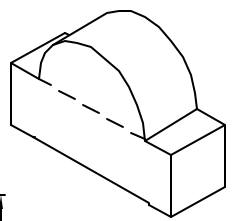

REFLOW PROFILE

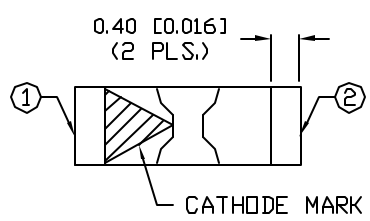
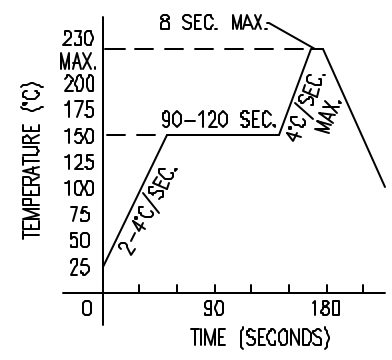

ELECTRO-OPTICAL CHARACTERISTICS $T_A=25^{\circ}C$ $I_f=20mA$

PARAMETER	MIN	TYP	MAX	UNITS	TEST COND
PEAK WAVELENGTH		525		nm	
FORWARD VOLTAGE		3.5	4.0	V_f	
REVERSE VOLTAGE	5.0			V_r	$I_f=100\mu A$
AXIAL INTENSITY		45		mcd	$I_f=20mA$
VIEWING ANGLE		160		2x theta	
EMITTED COLOR:	GREEN				
EPOXY LENS FINISH:	WATER CLEAR				

LIMITS OF SAFE OPERATION AT 25°C

PARAMETER	MAX	UNITS
PEAK FORWARD CURRENT*	160	mA
STEADY CURRENT	25	mA
POWER DISSIPATION	100	mW
DERATE FROM 25°C	-1.2	mW/°C
OPERATING TEMP.	-25 TO +85	°C
STORAGE TEMP.	-30 TO +85	°C

* $t < 10\mu S$

RECOMMENDED PAD LAYOUT

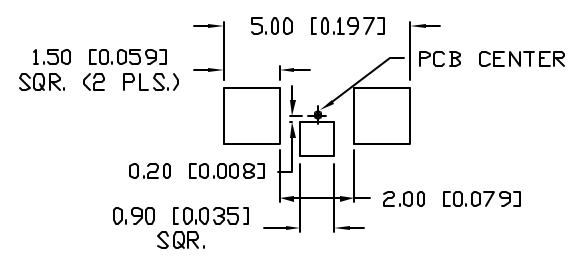
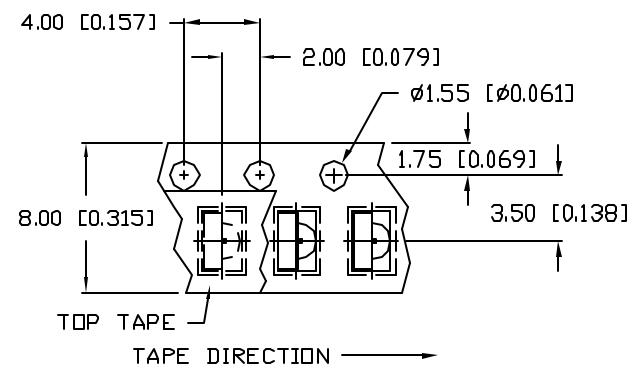

CAUTION: MOISTURE SENSITIVE DEVICE
PER JEDEC LEVEL 4 STANDARDS

NOTES:

- 2,000 PER REEL
- THE CATHODE IS ORIENTED TOWARDS THE TAPE SPROCKET HOLE.

UNCONTROLLED DOCUMENT

*UNLESS OTHERWISE SPECIFIED TOLERANCES PER DECIMAL PRECISION ARE: X=±1 (+0.039), X.X=±0.5 (+0.020), X.XX=±0.25 (+0.010), X.XXX=±0.127 (+0.005). LEAD SIZE=±0.05 (0.002), LEAD LENGTH=±0.75 (+0.030). MIN.= +DECIMAL PRECISION MAX.= +0.00 -DECIMAL PRECISION

REV.	PART NUMBER
A	SML-LXR851UPGC-TR

CONFIDENTIAL INFORMATION
THE INFORMATION CONTAINED IN THIS DOCUMENT IS THE PROPERTY OF LUMEX INC. EXCEPT AS SPECIFICALLY AUTHORIZED IN WRITING BY LUMEX INC., THE HOLDER OF THIS DOCUMENT SHALL KEEP ALL INFORMATION CONTAINED HEREIN CONFIDENTIAL AND SHALL PROTECT SAME IN WHOLE OR IN PART FROM DISCLOSURE AND DISSEMINATION TO ALL THIRD PARTIES.



290 E. HELEN ROAD
PALATINE, IL 60067-6976
PHONE: +1.847.359.2790
US WEB: www.lumex.com
TW WEB: www.lumex.com.tw

1.0mm x 3.0mm PCB RIGHT ANGLE SURFACE MOUNT LED,
525nm GREEN, WATER CLEAR LENS, 2K PER REEL.

RELIABILITY NOTE
OUR MANY YEARS OF EXPERIENCE, DATA ACCUMULATION INDICATE THAT SOLDER HEAT IS A MAJOR CAUSE OF EARLY AND FUTURE FAILURE. PLEASE PAY ATTENTION TO YOUR SOLDERING PROCESS.

DRAWN BY:	CHECKED BY:	APPROVED BY:	DATE: 10.22.98
BC			PAGE: 1 OF 1
			SCALE: N/A